

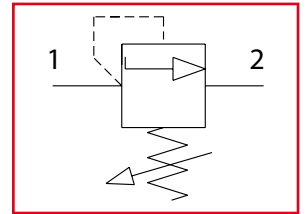

VMD30

Valvole di massima pressione
Relief valves



LEHENGOMAK, S.p.A.



Dati tecnici Technical data	
Viscosità fluido Fluid viscosity	10-500 mm ² /s 45 to 2000 ssu (6 to 420 cSt)
Classe di contaminazione Filtration	ISO code 16/13 SAE class 4 or better
Temperatura fluido Fluid temperature	-20°C +80°C -4°F +176°F
Temperatura ambiente Ambient temperature	-20°C +50°C -4°F +122°F

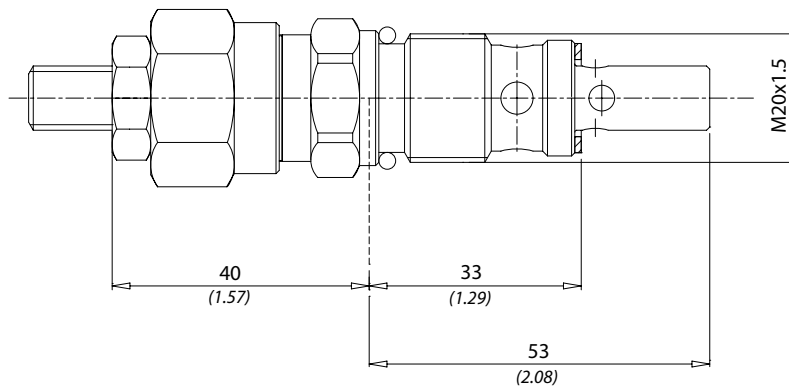
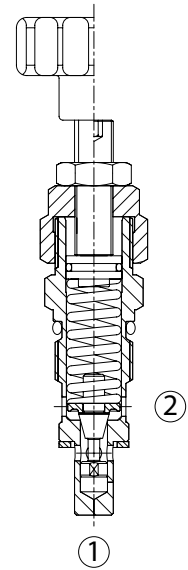

mm
(Inches)

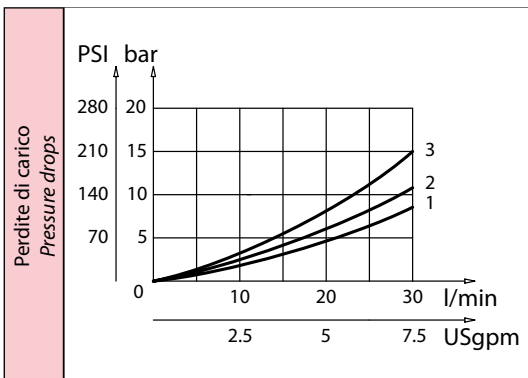
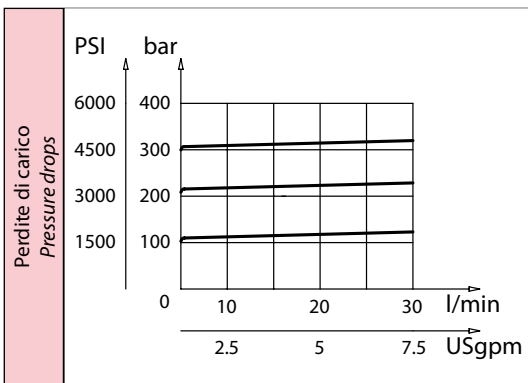

Codice ordinazione Ordering code			
VMD30 - X - Y			
X	Regolazione / Setting	Y	Molla - Spring
C		1	100 bar (1450 PSI) max
		2	210 bar (3000 PSI) max
		3	300 bar (4350 PSI) max
V			

Caratteristiche tecniche Technical performances					
Codice Code	Portata Max Max flow l/min - USgpm	Pressione Max Max pressure bar/PSI	Peso approssimativo Approx weight Kg / lb	Coppia di serraggio Tightening torque Nm / lbf ft	Cavità Cavity
VMD30	30 (8)	320 (4500)	0,16 (0.35)	25-30 (19-22)	C2015/30